



ALT by Keiji Takeuchi
Datenblatt
Fact sheet

FAUST

Keiji Takeuchi



Keiji Takeuchi (1977) wurde in Fukuoka, Japan, geboren und verbrachte den Großteil seiner Jugend in Neuseeland, wo er einen Bachelor-Abschluss in Produktdesign erwarb. Im Jahr 2005 trat er in die Firma Naoto Fukasawa Design Ltd. ein. Nachdem er 7 Jahre in seinem Büro in Tokio verbracht hatte, zog Takeuchi nach Mailand und baute das europäische Satellitenbüro von Fukasawa auf. Ende 2015 erweiterte Takeuchi natürlich seine Aktivitäten und beschloss, sein eigenes Studio in Mailand zu eröffnen. Heute arbeitet Takeuchi mit verschiedenen internationalen Marken wie Boffi, De Padova, Living Divani, Geiger / Hermanmiller, Ligne Roset, Cruso, Fredericia, Ichendorf, Jaxon Koen/Lixil, e'interiors und anderen zusammen.

Born in Fukuoka, Japan, Keiji Takeuchi (1977) spent most of his youth in New Zealand where he graduated with a bachelor in product design. In 2005 he entered Naoto Fukasawa Design Ltd. After spending 7 years at his office in Tokyo, Takeuchi moved to Milan and set up Fukasawa's European satellite office. In late 2015, Takeuchi naturally expanded his activities and he decided to set his own studio in Milan. Today Takeuchi is collaborating with various international brands such as Boffi, De Padova, Living Divani, Geiger / Hermanmiller, Ligne Roset, Cruso, Fredericia, Ichendorf, Jaxon Koen/Lixil, e'interiors and others. www.keijitakeuchi.com

Produktinformation

Das ALT-Tischsystem von Keiji Takeuchi zeichnet sich durch einen einzigartigen konischen Unterbau aus, der mit Linoleum beschichtet ist. Dieser Konus beinhaltet einen tragbaren Gewichtstank, der, wenn er mit Wasser oder Sand gefüllt ist, Stabilität gewährleistet. Dadurch wird das Gesamtgewicht während des Transports und somit auch der CO₂-Fußabdruck reduziert.

Das ALT-System bietet mit seinen zwei verschiedenen Konusgrößen eine breite Palette von Tischkonfigurationen.

Hergestellt in: Deutschland

Produkteinführung: 2023

Farben

Alle Linoleum Farben

Gewicht

S (20 kg); Mit Wasser gefüllt (36 kg) / Mit Sand gefüllt (48 kg)
L (33 kg); Mit Wasser gefüllt (58 kg) / Mit Sand gefüllt (77 kg)

Materialien

Tischplatte (optional): Holz, Linoleum
Konus: Linoleum, Recyceltes Leder, Valchromat
Tragbarer Gewichtstank:
PE-LLD (100% recycelter Kunststoff)
Metallbasis: Pulverbeschichteter Stahl
Kabelbehälter (optional):
ABS (100% recycelter Kunststoff)
Kabelabdeckung (optional):
Eloxiertes Aluminium, Linoleum

Optionales

Der Tisch kann optional mit einem Kabelmanagement ausgestattet werden. Dieses umfasst einen Kabelbehälter und eine Kabeldurchführung am unteren Ende des Konus sowie einen mit Linoleum beschichteten Deckel, der flächenbündig in die Tischplatte integriert ist und die Kabel in die gewünschte Richtung führt.

Konfigurationen

ALT ist als einzelner Konus oder als Paar in den Größen Small und Large erhältlich. Der Konfigurator wählt automatisch den passenden Konus auf Grundlage der Tischplattenform- und -größe.

Product information

The ALT table system by Keiji Takeuchi features a unique conical base lined with rolled-up linoleum. This base embeds a portable weight tank which when filled with water or sand, ensures stability while reducing the overall weight during transportation, and so minimizing environmental impact.

With two sizes of cone-shaped bases to choose from, the ALT system offers a wide range of table configurations.

Made in: Germany

Product Release: 2023

Colours

All Linoleum colours

Weight

S (20 kg); Water filled (36 kg) / Sand filled (48 kg)
L (33 kg); Water filled (58 kg) / Sand filled (77 kg)

Materials

Tabletop (optional): Wood, Linoleum
Table column:
Linoleum, Recycled leather, Valchromat
Portable weight tank:
PE-LLD (100% recycled plastic)
Metal base: Powder coated steel
Cable tray (optional): ABS (100% recycled plastic)
Cable lid (optional): Anodized aluminium, Linoleum

Optionals

The table can be optionally equipped with integrated cable management features. These include a cable tray and a cable hole at the base, as well as a linoleum-covered lid that sits flush with the table surface and helps guide cables as needed.

Configurations

ALT is available as a single column or pair, in both Small and Large sizes. The configurator automatically selects the suitable setup based on the tabletop shape and size.

Kabeldeckel
Cable lid
(optional)

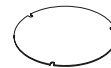

Tischplatte
Tabletop
(optional)

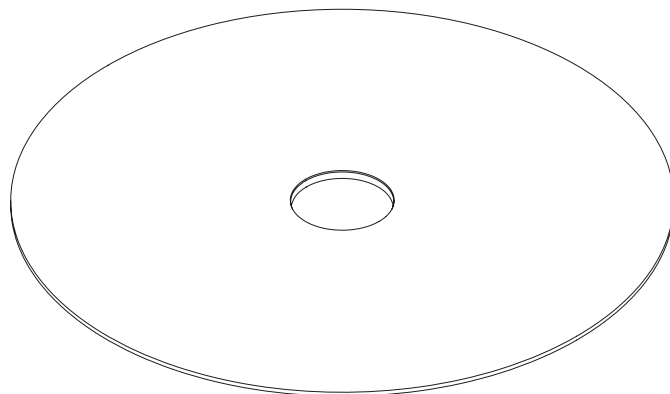

Kabelbehälter
Cable tray
(optional)



Klammer
Clamp



4 x Schrauben
4 x Screws

Konus
Column

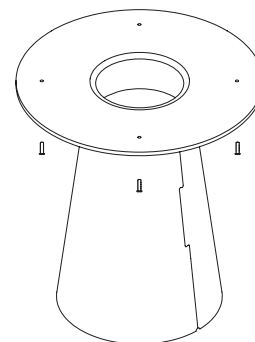

Tragbarer Gewichtstank
Portable weight tank



ALTS

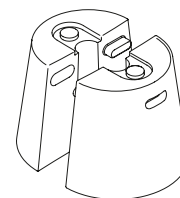

ALTL

Metallbasis
Metal base

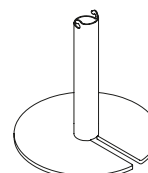

ALTS

Für Tischplatten /
For tabletops:
< 120 cm

Es werden 2 Gestelle
verwendet, wenn /
2 stands used when
Länge / Length:
< 160 cm
Tiefe / Depth:
< 120 cm

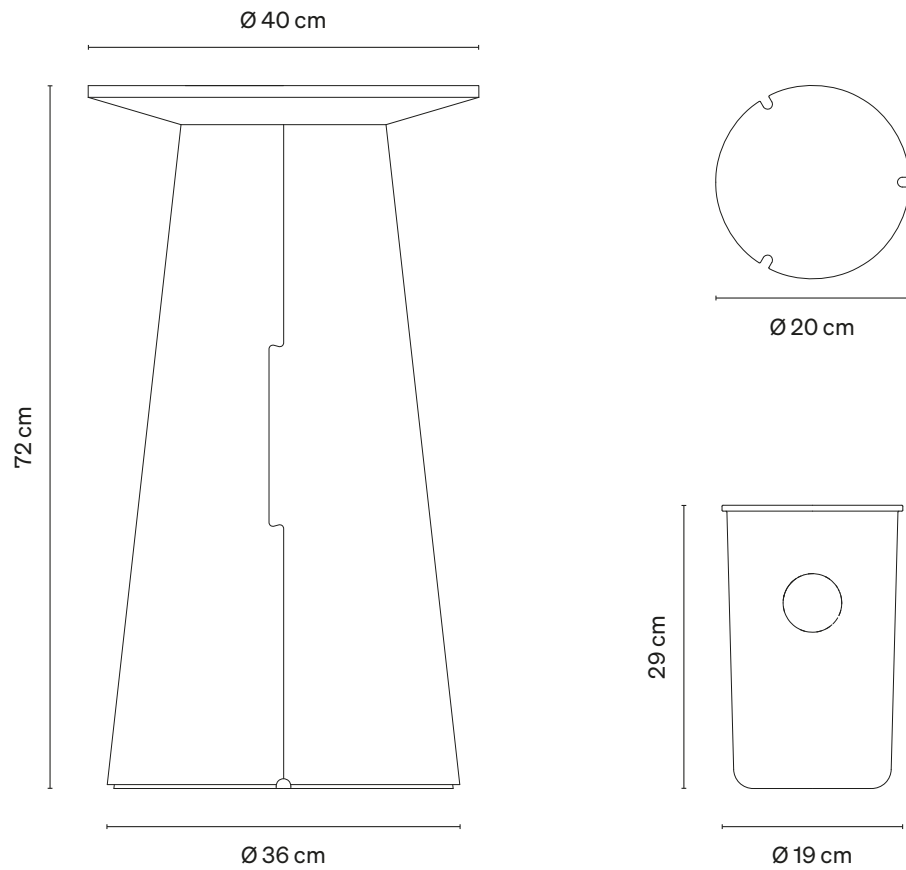

ALTL

Für Tischplatten /
For tabletops:
 ≥ 120 cm

Es werden 2 Gestelle
verwendet, wenn /
2 stands used when
Länge / Length:
 ≥ 160 cm
Tiefe / Depth:
 ≥ 120 cm

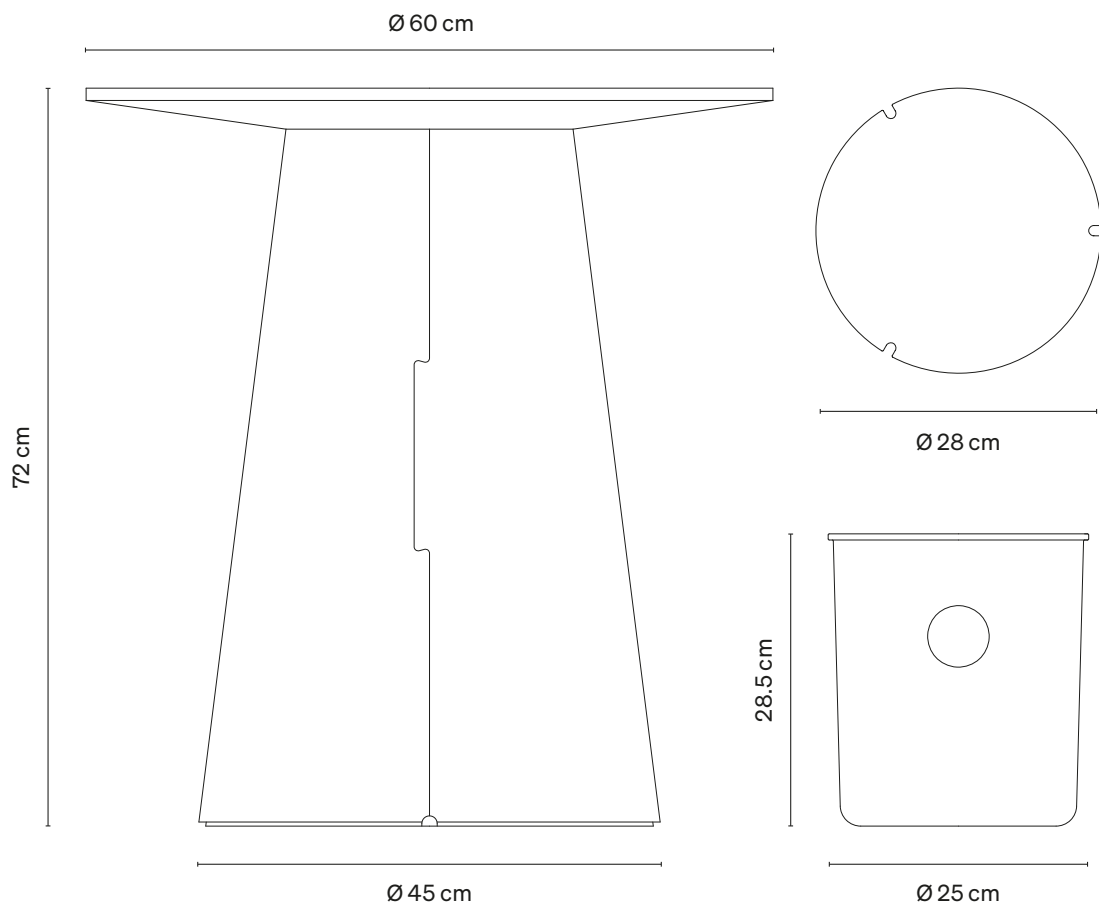

Material und Ausführung / Material and finish

Linoleum



4132 Ash



4176 Mushroom

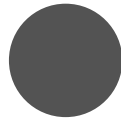

4012 Basalt ^{NEW}

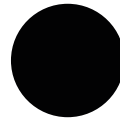

4023 Nero



4009 Espresso ^{NEW}



4008 Brick ^{NEW}



4007 Macadamia ^{NEW}



4154 Burgundy



4003 Walnut



4175 Pebble

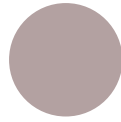

4010 Soft Lilac ^{NEW}



4172 Mauve



4183 Pistachio



4184 Olive



4011 Taupe ^{NEW}



4174 Confier



4179 Smokey Blue



4004 Blue Haze ^{NEW}



4177 Vapour



4005 Denim ^{NEW}



4002 Leather



4001 Clay



S588 Pure Linoleum

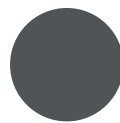

4155 Pewter



Plattenform / Shape:
Round, Ø120 cm

**Materialien und
Farben / Materials
and colors:**
Tabletop: S588
Pure Linoleum
Column: S588 Pure
Linoleum

**Plattenstärke /
Thickness:** 29 mm

**Plattenart / Core
material:**
Multiplex massiv /
Plywood

**Kantenschräge /
Edge skew:**
90°

**Größe der Konus /
Column size:**
ALT L



Plattenform / Shape:
Round, Ø160 cm

**Materialien und
Farben / Materials
and colors:**
Tabletop:
Linoleum, 4174
Conifer
Column: Linoleum,
4183 Pistachio

**Plattenstärke /
Thickness:** 29 mm

**Plattenart / Core
material:**
Multiplex massiv /
Plywood

**Kantenschräge /
Edge skew:**
90°

**Größe der Konus /
Column size:**
ALT L



Plattenform / Shape:
Rectangular,
155x100 cm

**Eckradius / Corner
radius:** 12 cm

**Materialien und
Farben / Materials
and colors:**
Tabletop: Linoleum,
4166 Charcoal
Column: Linoleum,
4166 Charcoal

**Plattenstärke /
Thickness:** 30 mm

Kante / Edge:
ABS, 4166 Charcoal

**Kantenschräge /
Edge skew:**
90°

**Größe der Konus /
Column size:**
ALT L



Plattenform / Shape:
Rectangular,
320x120 cm

**Eckradius / Corner
radius:** 3 cm

**Materialien und
Farben / Materials
and colors:**
Tabletop: Linoleum,
4005 Denim^{NEW}
Column: Linoleum,
4023 Nero

**Plattenstärke /
Thickness:** 30 mm

Kante / Edge:
Umleimer aus
Eiche / Oak veneer

**Kantenschräge /
Edge skew:**
90°

**Größe der Konus /
Column size:**
ALT S